

Zaor[®]



Isostand

Technical Specifications

Isostand:

This top of the line speaker stand features the finest design and finish ZAOR could come up with. The paint job is applied in several layers and baked at high temperatures to obtain its unique shine and resistance. The double mounting on spikes resting on metal plates, themselves resting upon a layer of AERstop is a unique design and provides stability and acoustic isolation beyond compare. The speaker itself rests upon a plate of special hardend glass. The Isostand is adjustable in height and can thus perfectly match the situation in your listening environment.

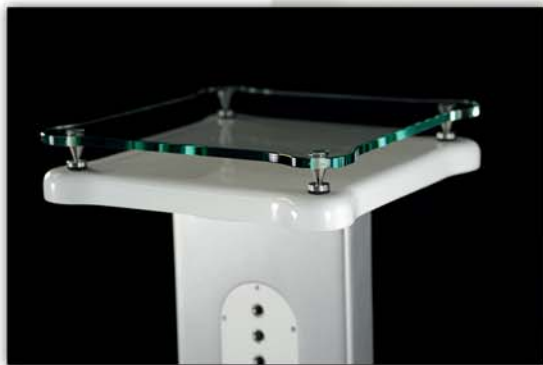

Specifications:

- Height: 860 - 1240 mm (min to max)
- Top: 350 x 350 mm *or* 400 x 400 mm
- Bottom: 350 x 400 mm *or* 400 x 450 mm
- Adjustable in height
- Twofoldly decoupled
- Supports up to 80kg

Technical Plan (measuring unit: mm)

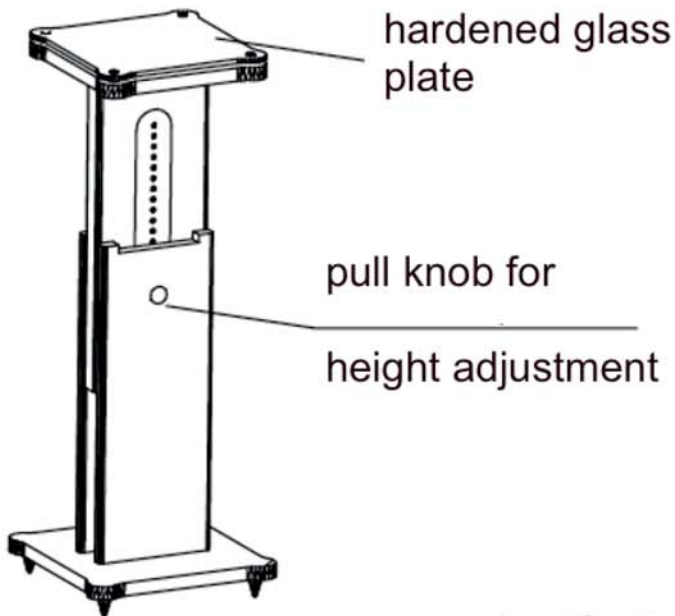

Isostand 35 x 35

isostand 40 x 40

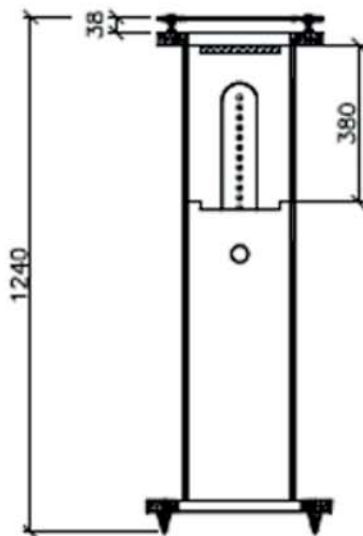
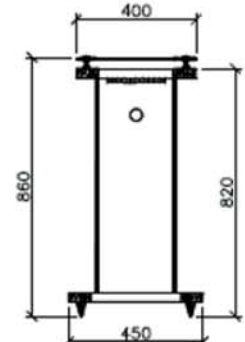
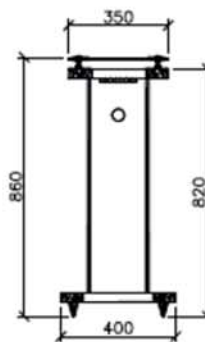

adjustable in
14 steps: min 860mm
max 1240 mm

Isostand 35 x 35

isostand 40 x 40

speaker support

Base

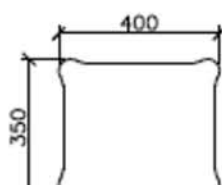
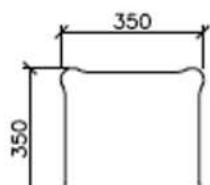

speaker support

Base

